

G-100



ASSEMBLY INSTRUCTIONS

WITH TELESCOPIC RODS

Prodotto da: Garlando srl Via Regione Piemonte, 5 Zona Ind. D1 15068 Pozzolo Formigaro (AL) ITALY



WARNING, READ AND KEEP
This product is not suitable for use by children under 3 years.
Small balls might be swallowed or inhaled.

Care and maintenance

Congratulations! You have bought a first quality table.

It is an indoor table: please assemble it and use it indoors only.

IMPORTANT: Once assembled your table is quite wide and may not fit through your doors. For this reason you should assemble it in the room you intend it to be used. Should you wish to move your table to another room, it might be necessary to remove its legs.

In order to ensure the table long life and continued playing appeal, we recommend that you follow the instructions below.

Caution

Your table has been manufactured for indoor playing: do not leave it outdoors. Rain, snow and high humidity may damage its materials. Prolonged exposure to the sun is to be avoided too, due to its bleaching effects on the colours.

Standard cleaning

Clean your table periodically by rubbing its surfaces with a damp cloth to eliminate dust and other dirt residuals.

Deeper Cleaning

You can use any household detergent which does not contain wax or abrasives, having care to completely take it off.

Ammonia-based cleaners, scoring compounds, or solvents such as acetone, gasoline, etc. should absolutely be avoided, as these will damage the colours, especially those of the cabinet.

Do not flood the table.

Playfield

If the table has a glass playfield, beware not to wet the card below, which could wave.

Bars and bearings

Garlando roller bearings do not require any lubrication. However, should you wish to furtherly improve their smoothness, employ a good quality silicone spray, such as Garlando's proposal Slidy, which has a lubricating and protective double action. Be careful not to use any vegetal or any other type of grease which may attract dirt and clog the roller bearings.

Using a spray is also useful to prolong the bar chromium-plating.

Use of protection cover

For a better protection from dust, especially if the table is not used for a longtime, the use of the protection cover is advised.

Garlando does not accept any responsibility for damages resulting from disregarding these instructions.

Components



8 Pcs.
Plastic handle



2 Pcs.
Ball entry fillers



2 Pcs.
Score counters



2 Pcs.
Ball Baskets



4 Pcs
Adjustable foot



4 Pcs.
Metal legs



16+16 Pcs.
Bolt + washer for leg fixing

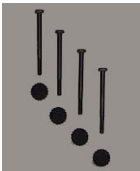

4 + 4 Pcs
Bolt + knob for adjustable foot



8 Pcs.
Set of telescopic rods with inner rods



8 Pcs.
Roller bearing



**8 Pcs.
Outside Bearing**



**16 Pcs.
Inside bearing retainer**



**8 Pcs
End stop bush**



**10 Pcs.
Ball**

Leg assembly

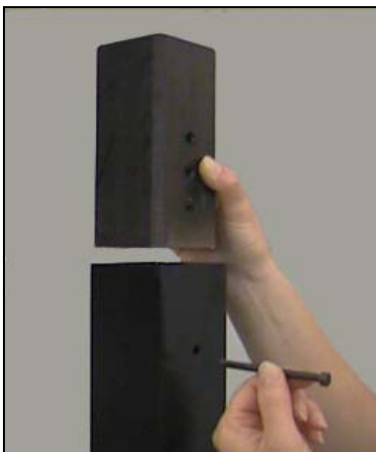
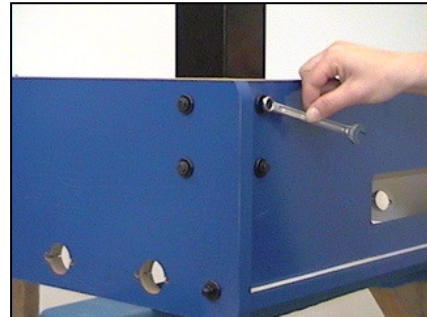
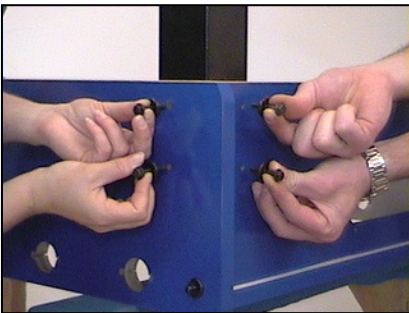

Rod position

GB - The football-table is equipped with 4 rods for each team:

- Goalkeeper (1 player-rod): at the end of the playfield. **Position A**
- Defence (2 player-rod): in front of the same colour goalkeeper. **Position B**
- Mid-fielder (5 player-rod): in the middle of the playing field, in front of the 5-player rod of the opposite colour. **Position C**
- Forward (3 player-rod): in front of the 2 player-rod of the opposite colour. For example: the blue forward rod faces the red defence rod. **Position D**

GB - Start by placing the 1 player-rod and then all the others of same colour following the abovementioned positions. Do the same for the other colour team.

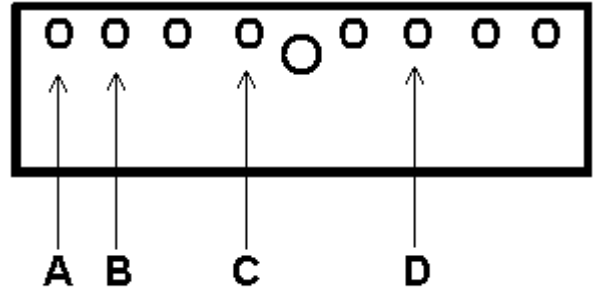
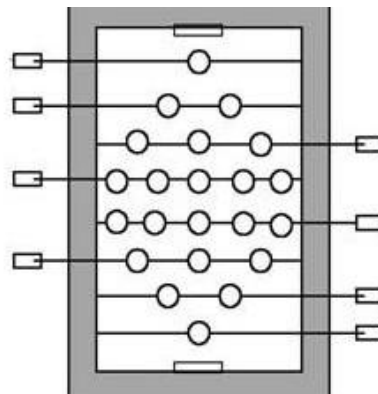

Diagram of final assembly

Red counter

Red player side



Blue player side

Blue counter

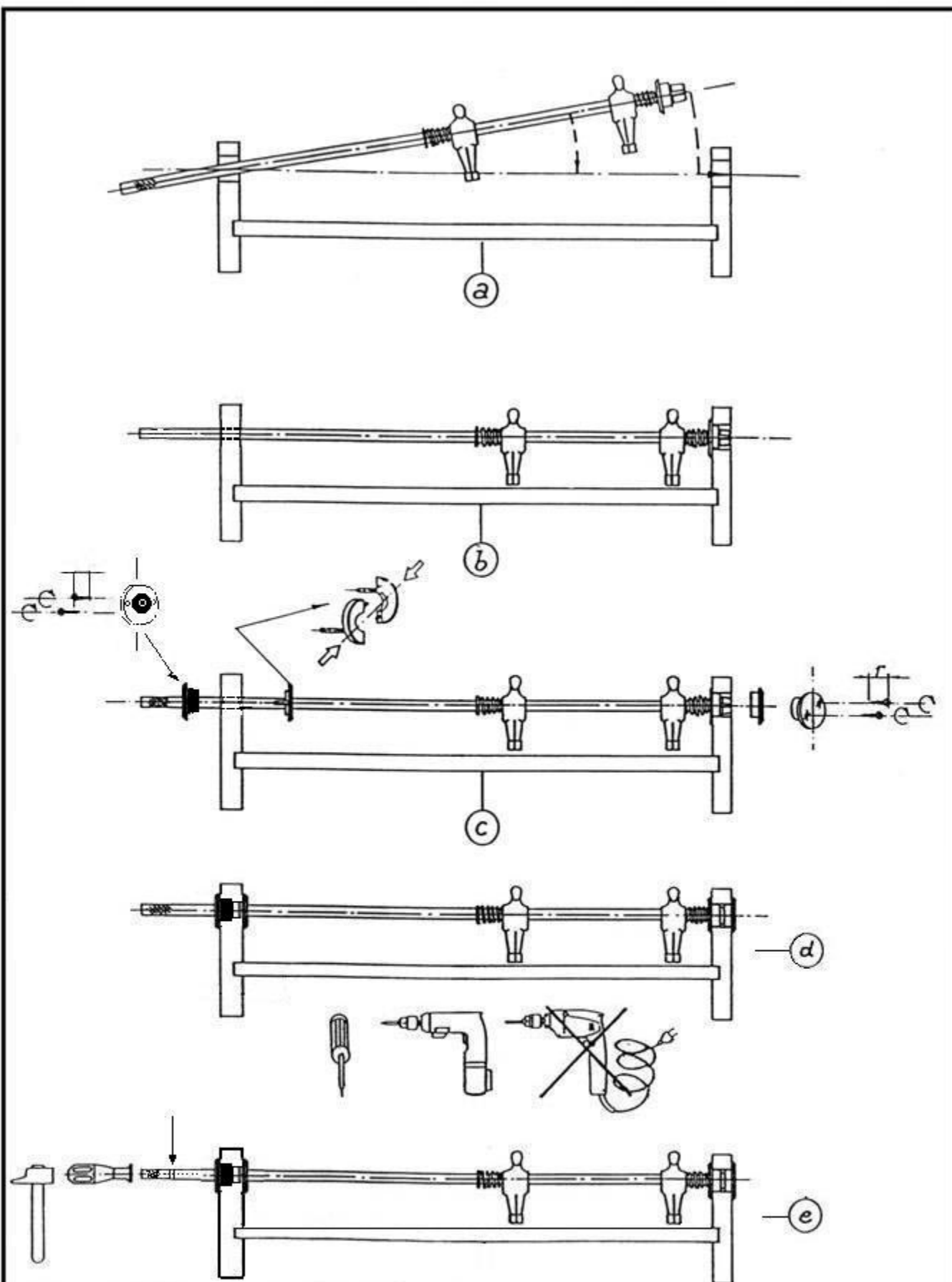

Attenzione! Calzare le manopole fino a coprire completamente le incisioni sull'asta
Achtung! Stecken Sie die Griffe bis die Bedeckung der Stange-Einschnitte.

Beware! When fixing the handle, make sure that you push it enough to cover the ridges completely

Attention ! En fixant les poignées couvrez le moletage complètement

BEWARE NEW MODEL

Please follow these assembly instructions

Roller bearing

INT =

Side of the bearing that must look towards the playfield

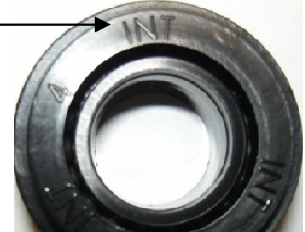

Outside Bearing retainers

Inside bearings retainers

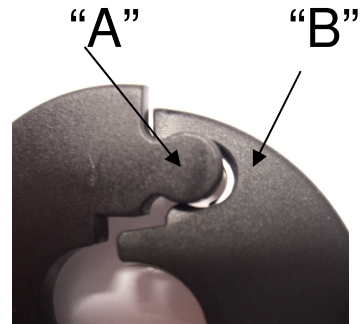

To match the two bearings, rest them on the bar while keeping them slanting so that the protruding part "A" is in front of the hollow part "B", then bring them vertical by a slight pression.

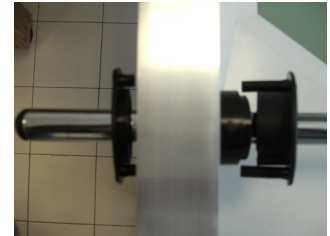
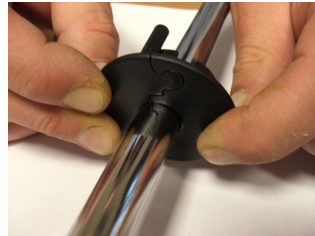
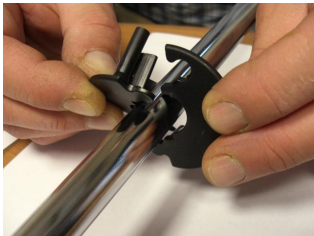

N.B. If you use an electric screw driver, set the torque at the minimum.

Accessory assembly

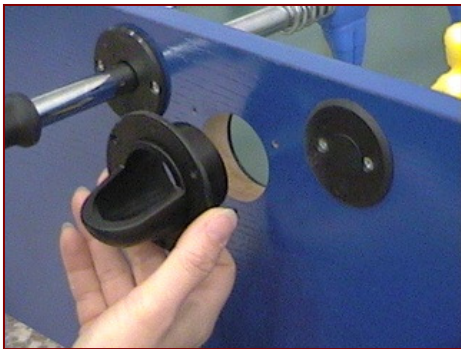
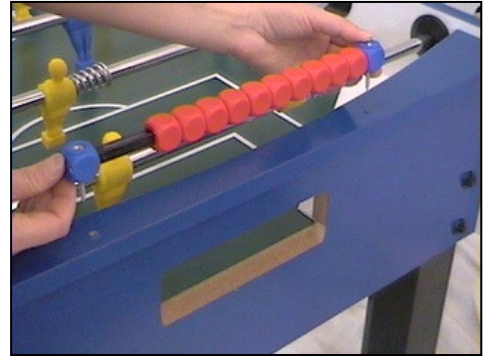
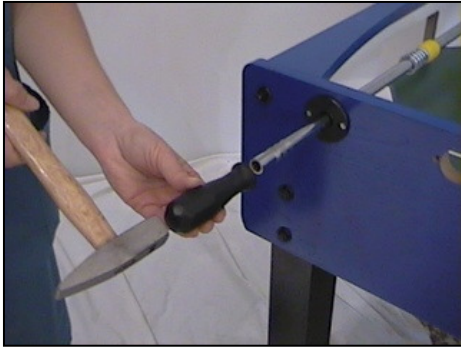

Insert manually the ball entry fillers, insert and tighten the screws into the holes. Do the same with the other ball entry filler.

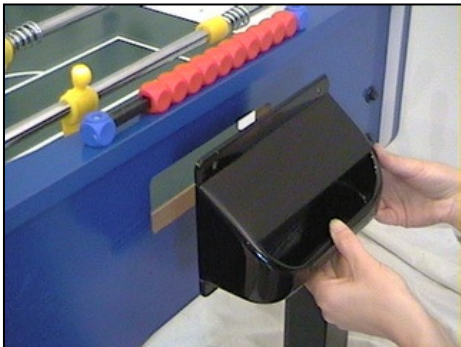

FOOTBALL-TABLE DEMOLITION AND HARMFUL MATERIAL REMOVAL

Demolition:

This football table does not require any particular care for the demolition as it does not contain any parts produced with dangerous materials. These materials are **wood, MDF, steel, aluminium, ABS, PP (moplen), PE, PVC, glass**. These materials are present in the following parts:

Frame: wood, MDF, steel

Legs: wood, steel

Playfield: wood, glass.

Rods: steel, PP (moplen)

Accessories: ABS, PE, PVC

Finishing: aluminium, ABS.

During the football-table demolition we suggest to separate the different materials and bring them to authorized collection centre for recycling.

Removal of harmful materials

The football-table does not contain or produce any harmful substances.

DICHIARAZIONE CE DI CONFORMITÀ

Il fabbricante : **GARLANDO S.r.l.**
Via Regione Piemonte, 5 - 15068 POZZOLO FORMIGARO (AL)

Dichiara che il giocattolo: **CALCIOBALILLA mod. G-100**

è conforme alle disposizioni della direttiva sulla sicurezza dei giocattoli
(direttiva 88/378/CEE), e successivi emendamenti (direttiva 93/68/CEE);

Inoltre dichiara che sono state applicate le seguenti norme armonizzate:

UNI EN 71-1, UNI EN 71-2, UNI EN 71-3, EN 50088

Pozzolo Formigaro, li 01/10/2004

IL FABBRICANTE

Garlando s.r.l.

